

**Installation Instructions**  
**SKU# 060434 (LD-B53026-W2)**  
**Rated Voltage 230-240V~ 50Hz**

**PLEASE READ AND SAVE ALL INSTRUCTIONS CAREFULLY BEFORE USING THE PRODUCT**

**WARNING** - to reduce the risk of fire, electrical shock or injury to persons or property, please follow the guideline below for safe use and installation.

**INSTALLATION REQUIREMENTS:**

- **Must be installed by a Licensed Electrician.**
- **Must be installed according to the current wiring rules AS/NZS3000.**
- **Do not exceed the maximum wattage rating**
- **Suitability for use “indoors”**

**INSTALLATION DIRECTION:**

- Take care not to pull any wires during unpacking as a bad connection may occur.
  - Level all the components on a smooth surface and make sure there is no component missing before assembly.
  - Check whether the fitting has been damaged during transport. Do not operate/install any product which appears damaged in any way. Return the complete product to the place of purchase for inspection, repair or replacement.
  - Ensure all power connection is off for your own safety.
  - Select a suitable location to mount the fitting. Ensure it is away from any air vents, damp or moist areas and hazards. The mounting point must be able to support 4 times the weight of the fitting.
1. Loosen the mounting bracket from the canopy.
  2. Using the mounting bracket, mark the holes on the wall.
  3. Drill holes in the wall and put the anchors into the holes. Secure the mounting bracket onto the wall via screws provided. Ensure the screws used are suitable for the mounting surface.
  4. Connect the mains supply wire to the light fitting using the terminal block provided. Ensure that the wires are secure and no bare wires are exposed.

**Mains Supply Wire**

Earth – Yellow/Green  
Neutral – Blue or Black  
Live – Brown or Red

**Fitting Wire**

Yellow/Green   
Blue  
Brown

5. Attach the lamp base to wall bracket and secure it on wall via tightening finials.
6. Hang up the crystal kits and install light bulbs (not included).

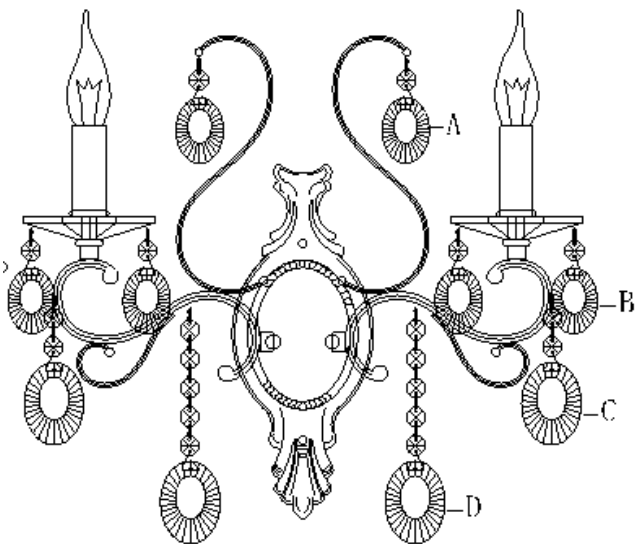
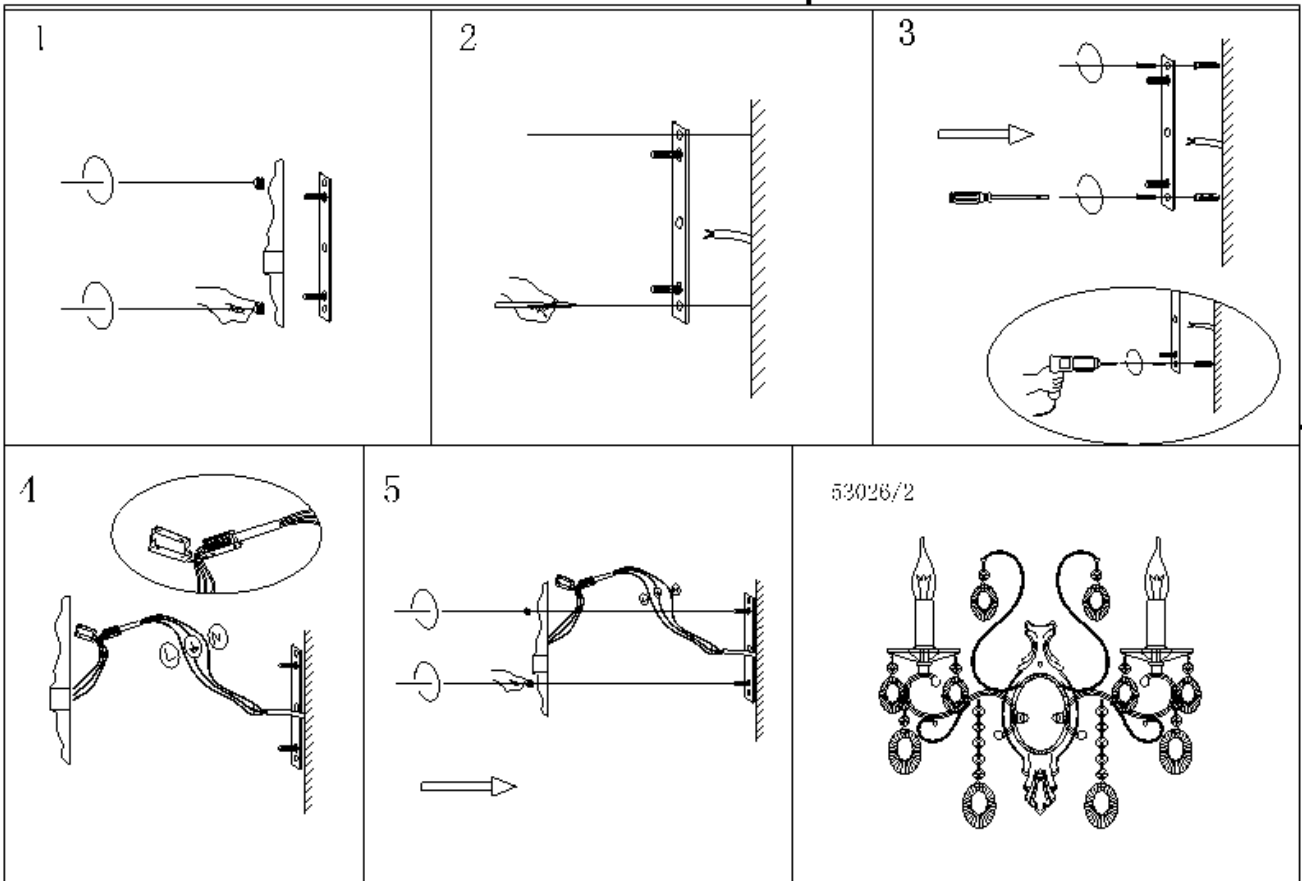

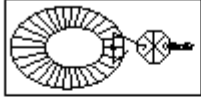
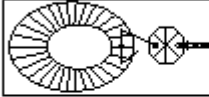
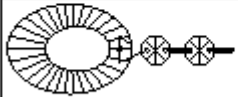
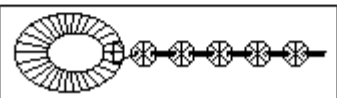
No.		Sets
A		2
B		8
C		2
D		2

**TIPS:**

1. To avoid injury or damage to the fitting, ensure that power leads and screws are secure before connecting the power.
2. Handle the fitting and cover/shade with care to avoid breakage.
3. When changing or cleaning bulbs, turn OFF power and allow cooling. Do not touch bulbs with bare hands, use gloves or a tissue.
4. Ensure that the fitting does not come in contact with corrosive chemicals, etc.
5. To clean, wipe with a damp clean cloth. Never soak the fitting with water.

**SPECIFICATIONS:**

<b>SKU #</b>	<b>MODEL #</b>	<b>RATED VOLTAGE</b>	<b>RATED POWER</b>	<b>RATED WATTAGE</b>	<b>LAMP HOLDER</b>
060434	LD-53026/W2	230-240V~50Hz	80W	2x Max. 40W	E14