

CUSTOM LED 80MM TRI COLOUR DOWNLIGHT

SKU# 170820, 170821

Rated Voltage 220-240V~ 50Hz

Thank you for purchasing this quality Lucci product. To ensure correct function and safety, please read and follow all instructions carefully before assembly, installation and use. Please keep instructions for future reference.

Warranty

- This luminaire is covered by a 5 year warranty. The warranty is from date of purchase, not the date of installation. Please retain proof of purchase.
- The use of non-compatible dimmers may damage your LED luminaire and will void your warranty.
- Warranty will be void if there is any damage due to improper usage or modification to the luminaire.
- Failure to comply with the instructions in this manual may increase the risk of damage or injury and will void warranty.

Installation Requirements

- Before installation, check the installation location in the ceiling has access to a socket outlet which is connected to a wall light switch and dimmer. If it does not, please contact a licensed electrician to arrange installation of the socket outlet, wall light switch and dimmer before continuing.
- All wiring and installation of the luminaire must adhere to latest local and national wiring rules. eg. AS/NZS 3000 Electrical installations. If unsure, please contact a licensed electrician.
- Select a suitable location for installation:
 - The mounting point must support 2 times the weight of the luminaire.
 - This luminaire is suitable for indoor use only.
 - Ensure the fitting is not installed in direct line of an air vent/system.
 - If installing a fitting in an area prone to moisture, ensure that the area is well ventilated and an appropriately rated exhaust fan is used if required. Damage or corrosion caused by moisture is not a product fault, and as such is not covered under warranty.

- This luminaire is dimmable and has been tested at the date of publication with the dimmers listed in the specification section. The use of a LED dimmer such as the Lucci LEDlux SKU# 290998 or SKU# 290997 dimmer is highly recommended.

NOTE: For the best dimming range, use with the Lucci LEDlux SKU# 290998 dimmer and adjust the variable resistor at minimum and maximum dimming positions on the dimmer during the installation.

NOTE: Dimming may cause buzzing sounds or a slight flicker. There may be slight delays with the LED light start up or slight uneven light performance when more than one LED luminaire is linked together, switched ON or dimmed. This is not a product fault and as such is not covered under warranty.

NOTE: Some dimmers have a minimum load of 20W. Ensure the dimmer position is on the maximum setting before turning on the LED light and adjust the dimmer down to your desired light level.

NOTE: Testing cannot account for installation variables such as variation in mains supply voltage, cable capacitance, electrical noise, transients, surges and ripple control signals (commonly found in NSW & QLD).

NOTE: The information provided is correct to the best of Beacon Lighting's knowledge at the date of publication.

- This luminaire has an insulating ceiling type IC-4 rating. Building insulation material can safely be exposed continuously to temperatures up to 90°C may abut and cover the luminaire. (Please refer to the Clearance Information section and the IC-4 Rating section in this instruction manual for further details.)
- If loose fill insulation or thermal insulation is not fixed into position or if there are loose combustible materials (e.g. leaves or combustible materials stored in the roof space), a barrier or guard is required as per the Clearance Information section in this instruction manual.

- The LED driver must be placed at least 100mm away from the LED downlight module to allow for cooling.
- The LED driver can be placed under the insulation. (Please refer to the Clearance Information section in this instruction manual for further details.)
- The LED downlight module is only suitable for use with Lucci LED Driver model#: DR-42V245-10W.
- The luminaire must not be used if the diffuser on the LED downlight module has been damaged or cracked.
- Take care not to pull any electrical wires during unpacking as this may damage the connection.
- Lay out all the components on a smooth surface and make sure there are no components missing before assembling. If parts are missing, return the complete product to the place of purchase for inspection or replacement.
- Check whether the luminaire has been damaged during transport. Do not operate/install any product which appears damaged in any way. Return the complete product to the place of purchase for inspection, repair or replacement.
- Ensure power to the circuit you are working on has been switched OFF before commencing any electrical work.

Installation Directions

Remove all packaging material from the product and be careful not to throw away accessories that may be hidden within the packaging material.

NOTE: Before the installation begins, plug the luminaire into a socket outlet to ensure the LED downlight is working correctly before installation.

1. Cut an installation hole of Ø 70mm into the ceiling.
2. Select the desired colour temperature using the switch on the back of the luminaire.
 - Set the switch towards the WW mark, then the luminaire will be set to CCT 3000K;
 - Set the switch towards the CW mark, then the luminaire will be set to CCT 4200K;
 - Set the switch towards the DL mark, then the luminaire will be set to CCT 6000K.
3. Push the springs up and install the LED downlight module into the cut-out hole.
4. Ensure all the clearance values are maintained during and after installation of the LED module, LED driver, thermal insulation, loose fill insulation, loose combustible materials and any structural members.

NOTE: Please refer to the Clearance Information section and the IC-4 section in this instruction manual for further details. Keep the luminaire 100mm away from the LED driver to allow for cooling.

5. Adjust the angle of the luminaire according to your need.

After the installation, switch on the luminaire to test all the lighting functions and enjoy your new lighting product.

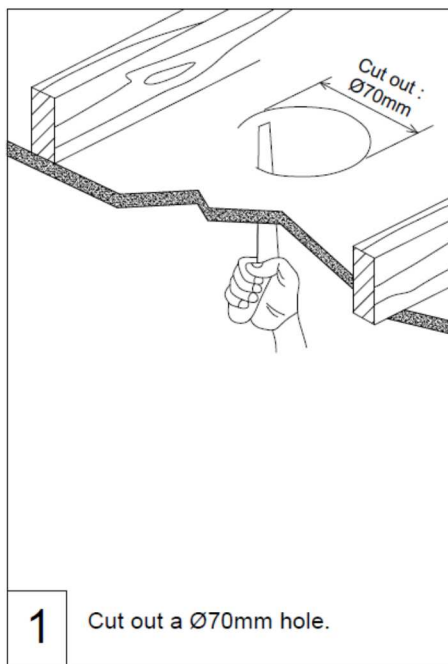

1 Cut out a Ø70mm hole.

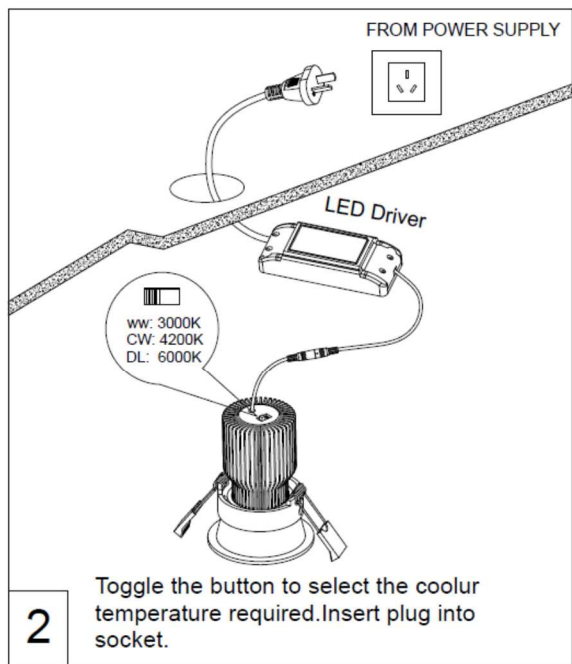

2 Toggle the button to select the colour temperature required. Insert plug into socket.

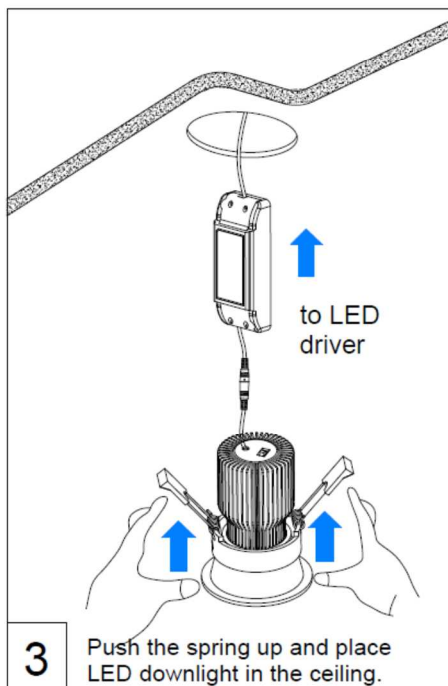

3 Push the spring up and place LED downlight in the ceiling.

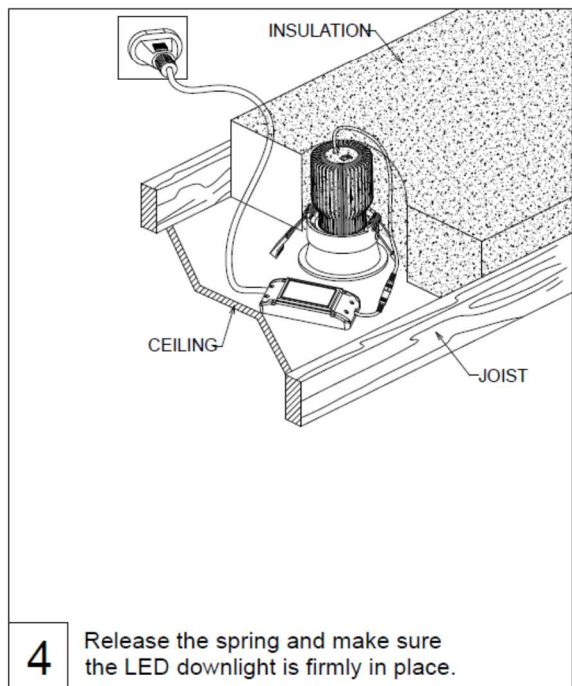

4 Release the spring and make sure the LED downlight is firmly in place.

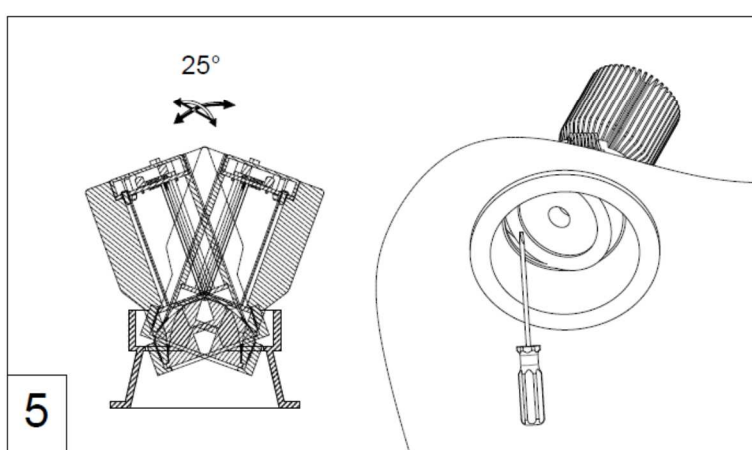

5

Clearance Information – AS/NZS 3000 Wiring Rules

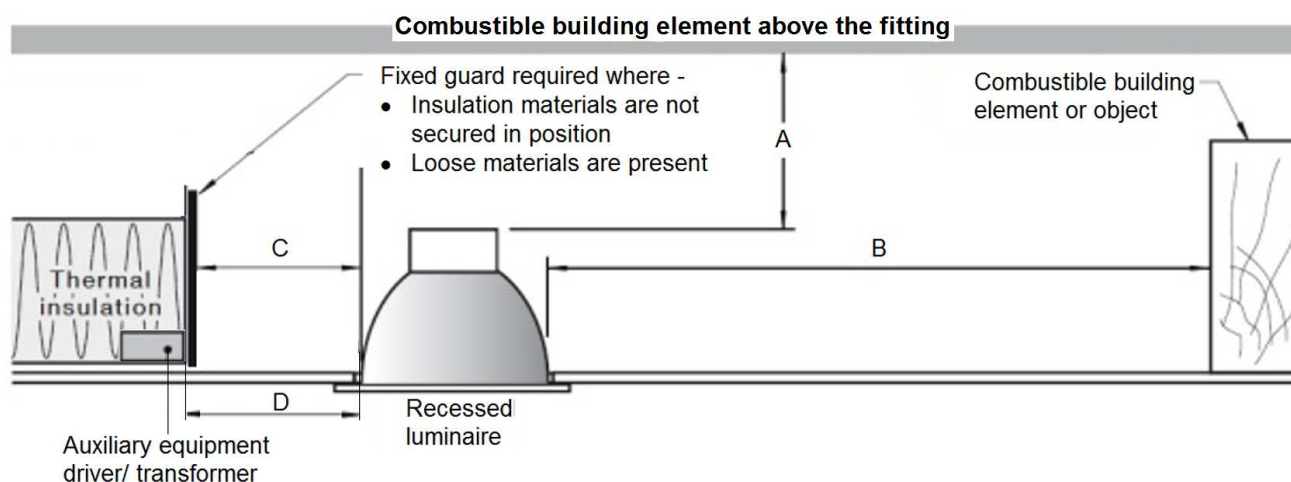

LOCATION	DISTANCE	DESCRIPTION
A	50 mm (Minimum)	Clearance between the top of the recessed luminaire and any combustible materials, building elements or objects above it.
B	50 mm (Minimum)	Clearance between the side of the recessed luminaire and any combustible materials, building elements or objects.
C	0 mm (Abutted)	Insulation can be abutted against the side of recessed luminaire and covered as per IC-4 Rating. See IC-4 Rating section for more details.
D	100mm	Auxiliary equipment/driver/transformer must be placed 100mm away from the luminaire. It can be placed under the thermal insulation and covered.

IC Rating – AS/NZS 60598.2.2: 2016

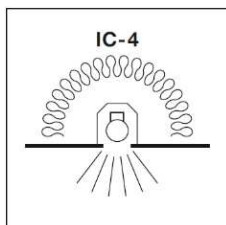

1. A closed luminaire that allows building insulation to come into contact with its sides and to cover it.
2. Type IC-4 recessed luminaire can be used together with building insulation that can safely be exposed continuously to temperatures up to 90°C may abut and cover the luminaire;

RISK OF FIRE – Required clearance from structural members and building elements
 SCB = 50 mm HCB = 50 mm

Safety tips

- Always ensure the power is OFF and the luminaire has cooled down before performing any maintenance, cleaning or making any adjustment to the luminaire.
- The external flexible cable or cord of this luminaire cannot be replaced; if the cable or cord is damaged, the luminaire shall be destroyed.
- The light source contained in this luminaire shall only be replaced by the manufacturer or his service agent or a similar qualified person.
- To avoid injury or damage to the luminaire, ensure that power leads and screws are secure before connecting the power.
- Select a suitable location away from liquids and hazards.
- Ensure that the luminaire does not come in contact with corrosive chemicals, etc.
- To clean, wipe with a damp clean cloth. Never soak the luminaire with water.

Troubleshooting		
PROBLEM	POSSIBLE CAUSE	SUGGESTED SOLUTION
Does not work. (New installation)	Wiring loose or no power to the downlight.	Check your circuit breaker/safety switch box and turn on power to your circuit.
		Unplug the downlight and test in a functional socket outlet with power. If the downlight does not switch on then contact your nearest Beacon Lighting store. If the downlight is working, have your licensed electrician check the wiring or socket outlet to the downlight.
Does not work. (Existing installation)	No power to the downlight.	Check your circuit breaker/safety switch box and turn on power to your circuit.
		Contact your nearest Beacon Lighting store.
Flickers when dimming. (New installation)	Non-compatible dimmer used.	Check the dimmer used. Ensure the dimmer used is on the list of compatible dimmers in this manual.
	Some dimmers have a variable loading adjustment function. eg. Lucci LEDlux SKU# 290998 dimmer. This may not have been adjusted during the installation of the dimmer.	The variable resistor needs to be adjusted to suit the downlight load to reduce the flickering.
Flickers when dimming. (Existing installation)	Dimmer position on low.	Ensure the dimmer position is on the maximum setting before turning on the downlights and adjust the dimmer down to your desired light level.
Buzzing sound.	Non-compatible dimmer used.	Check the dimmer used. Ensure the dimmer used is on the list of compatible dimmers in this manual.
Uneven light start up.	Dimmer position on low when switched on.	Ensure the dimmer position is on the maximum setting before turning on the downlights and adjust the dimmer down to your desired light level.

Specifications		
SKU #	170820	170821
Colour	Matte White	Matte Black
Rated Voltage	INPUT: 220-240V~ 50Hz, OUPUT: 27-42VDC, 245mA, constant current	
Rated Wattage	10W	
LED Specs	HONGLI LED, 3000K - 4200K – 6000K, CRI > 80, 700 lumens* *Lumen results are shown when set at 3000K; It may slightly vary at different CCT.	
Dimmer Information	Highly Recommended Dimmers	Compatible Dimmers
	Lucci LEDlux SKU# 290998, SKU# 290997	Buster + Punch DIM-002 LUMEX Load Smart LT1D450LS; DIGINET LED Smart MEDM; Clipsal 31E2RUDM, 32E450TM, 32E450UDM, 31E2PUDM and 32ELEDM; HPM: Cat. 400T
Weight	0.38kg	
Cut-out Size	Ø70mm	
IP Rating	IP20	
Dimensions	D:80mm x H:110mm	
Serviceable Parts	LED downlight module and LED driver are both serviceable.	
LED Driver Model #	Lucci DR-42V245-10W	