

TRANSITION DUEL TRI COLOUR LED DOWNLIGHT

SKU# 170890

Rated Voltage 220-240V~ 50Hz

Thank you for purchasing this quality Lucci product. To ensure correct function and safety, please read and follow all instructions carefully before assembly, installation and use of this luminaire. Please keep instructions for future reference.

Warranty

- This LED downlight is covered by a 5 year warranty valid for in-store replacement or refund only. The warranty is from date of purchase, not the date of installation. Please retain proof of purchase.
- The use of non-compatible dimmers may damage your LED downlight and will void your warranty.
- Warranty will be void if there is any damage due to improper usage or modification to the LED downlight.
- Failure to comply with the instructions in this manual may increase the risk of damage or injury and will void warranty.

Installation Requirements

- Before installation, check the installation location in the ceiling has access to a socket outlet which is connected to a wall light switch and dimmer. If it does not, please contact a licensed electrician to arrange installation of the socket outlet, wall light switch and dimmer before continuing.
- All wiring and installation of the luminaire must adhere to latest local and national wiring rules. eg. AS/NZS 3000 Electrical installations. If unsure, please contact a licensed electrician.
- The LED downlight module is rated IP44 only after it is fully installed, this must be maintained during installation.
NOTE: The LED driver and the back part of the LED downlight module is rated IP20.

- Select a suitable location for installation;
 - The mounting point must support 2 times the weight of the LED downlight.
 - This LED downlight is suitable for indoor or outdoor use, provided that it is installed under cover or under eaves.
- This LED downlight is dimmable and has been tested at the date of publication with the dimmers listed in the specification section. The use of a LED dimmer such as the Lucci LEDlux SKU# 290998 or SKU# 290997 dimmer is highly recommended.

NOTE: For the best dimming range, use with the Lucci LEDlux SKU# 290998 dimmer and adjust the variable resistor at minimum and maximum dimming positions on the dimmer during the installation.

NOTE: Dimming may cause buzzing sounds or a slight flicker. There may be slight delays with the LED light start up or slight uneven light performance when more than one LED light fitting is linked together, switched ON or dimmed. This is not a product fault and as such is not covered under warranty.

NOTE: Some dimmers have a minimum load of 20W. Ensure the dimmer position is on the maximum setting before turning on the LED light and adjust the dimmer down to your desired light level.

NOTE: Testing cannot account for installation variables such as variation in mains supply voltage, cable capacitance, electrical noise, transients, surges and ripple control signals (commonly found in NSW & QLD).

NOTE: The information provided is correct to the best of Beacon Lighting's knowledge at the date of publication.

- This LED downlight has an insulating ceiling type IC-4 rating. Building insulation material can safely be exposed continuously to temperatures up to 90°C may abut and cover the luminaire. (Please refer to the Clearance Information section and the IC-4 rating section in this instruction manual for further details.)
- If loose fill insulation or thermal insulation is not fixed into position or if there are loose combustible materials (e.g. leaves or combustible materials stored in the roof space), a barrier or guard is required as per the Clearance Information section in this instruction manual.
- The LED driver must be placed at least 100 mm away from the LED downlight module to allow for cooling.

- The LED driver can be placed under the insulation. (Please refer to the Clearance Information section in this instruction manual for further details.)
- The LED downlight module is only suitable for use with LED Driver model#: LB-PD-1167-10W.
- The LED downlight must not be used if the diffuser on the LED downlight module has been damaged or cracked.
- Take care not to pull any electrical wires during unpacking as this may damage the connection.
- Lay out all the components on a smooth surface and make sure there are no components missing before assembling. If parts are missing, return the complete product to the place of purchase for inspection or replacement.
- Check whether the fitting has been damaged during transport. Do not operate/install any product which appears damaged in any way. Return the complete product to the place of purchase for inspection, repair or replacement.
- Ensure power to the circuit you are working on has been switched OFF before commencing any electrical work.

Installation Directions

1. Remove all packaging material from the product and be careful not to throw away accessories that may be hidden within the packaging material.

NOTE: Before installation, plug the downlight into a socket outlet to ensure it is working correctly.

2. Select the colour temperature via the switch on the back of the downlight. (Fig. 1)
3. Cut an installation hole of $\varnothing 74\text{mm}$ into the ceiling. (Fig. 2).
4. Insert the plug into the socket outlet and ensure it is fully plugged in. (Fig. 3)
5. Push the springs up and put the LED downlight module up through the cut-out hole and into the ceiling. (Fig. 4)
6. Ensure all the clearance values are maintained during and after installation of the LED downlight module, LED driver, thermal insulation, loose fill insulation, loose combustible materials and any structural members. (Fig. 5)

NOTE: Please refer to the Clearance Information section and the IC-4 section in this instruction manual for further details.

7. After the installation, switch on the fitting to test all the lighting functions and enjoy your new lighting product.

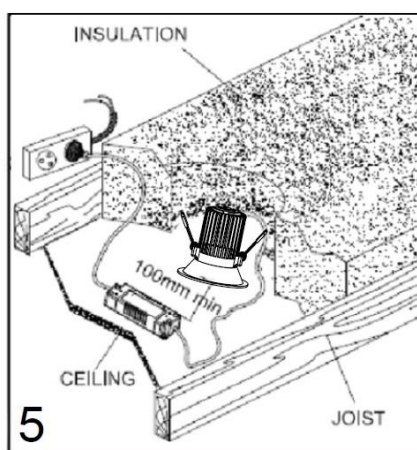
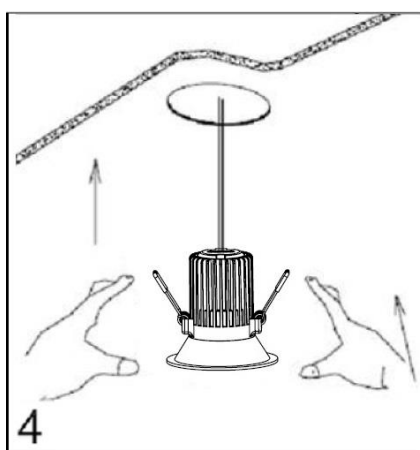
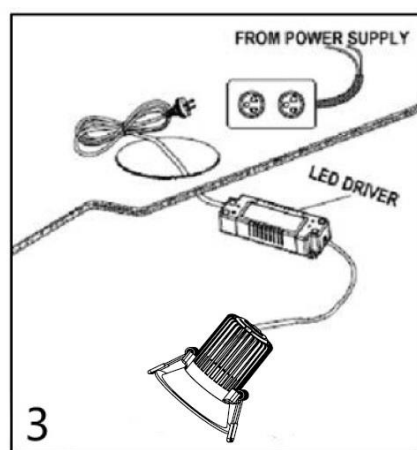
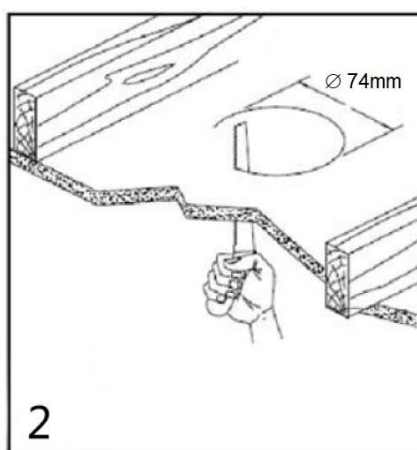
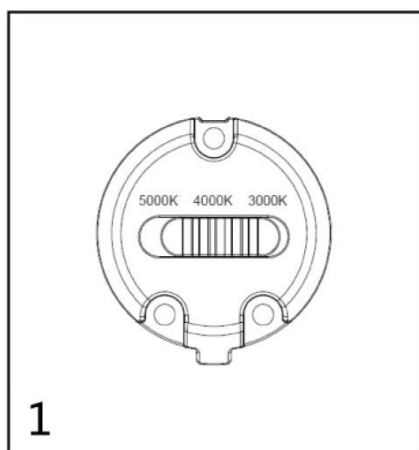

Clearance Information – AS/NZS 3000 Wiring Rules

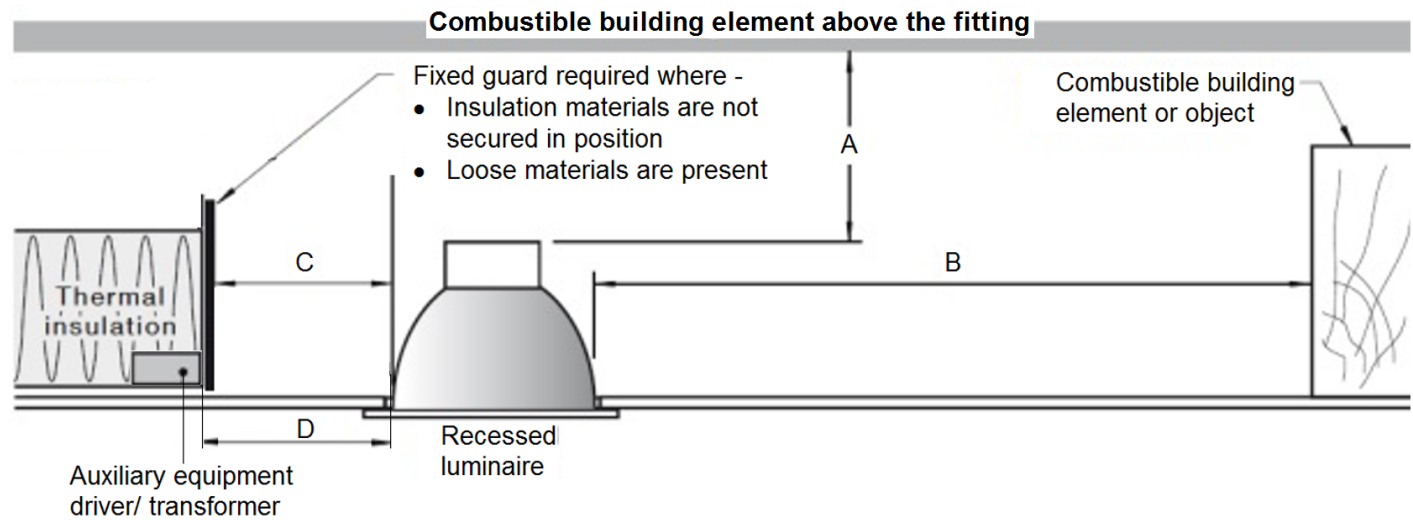

LOCATION	DISTANCE	DESCRIPTION
A	50 mm (Minimum)	Clearance between the top of the recessed luminaire and any combustible materials, building elements or objects above it.
B	50 mm (Minimum)	Clearance between the side of the recessed luminaire and any combustible materials, building elements or objects.
C	0 mm (Abutted)	Insulation can be abutted against the side of recessed luminaire and covered as per IC-4 or IC-F rating. See IC-4 or IC-F rating section for more details.
D	100mm	Auxiliary equipment/driver/transformer must be placed 100mm away from the luminaire. It can be placed under the thermal insulation and covered.

IC-4 Rating – AS/NZS 60598.2.2: 2016

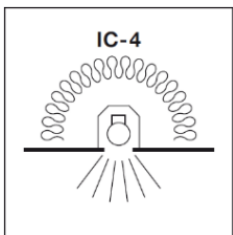

1. A closed luminaire that allows building insulation to come into contact with its sides and to cover it.
2. Type IC-4 recessed luminaire can be used together with building insulation that can safely be exposed continuously to temperatures up to 90°C may abut and cover the luminaire;

RISK OF FIRE – Required clearance from structural members and building elements
 SCB = 50 mm HCB = 50 mm

Safety Tips

- Always ensure the power is OFF and the LED downlight has cooled down before performing any maintenance, cleaning or making any adjustment to the LED downlight.
- The external flexible cable or cord of this luminaire cannot be replaced; if the cable or cord is damaged, the luminaire shall be destroyed.
- The light source contained in this luminaire shall only be replaced by the manufacturer or his service agent or a similar qualified person.
- To avoid injury or damage to the fitting, ensure that power leads and screws are secure before connecting the power.
- Select a suitable location away from liquids and hazards.
- Ensure that the fitting does not come in contact with corrosive chemicals/solvents or abrasive cleaners etc.
- To clean, wipe with a soft damp clean cloth. Do NOT soak or immerse the product in water or other liquids.

Troubleshooting		
PROBLEM	POSSIBLE CAUSE	SUGGESTED SOLUTION
Does not work. (New installation)	Wiring loose or no power to the downlight.	Check your circuit breaker/safety switch box and turn on power to your circuit.
		Unplug the downlight and test in a functional socket outlet with power. If the downlight does not switch on then contact your place of purchase. If the downlight is working, have your licensed electrician check the wiring or socket outlet to the downlight.
Does not work. (Existing installation)	No power to the downlight.	Check your circuit breaker/safety switch box and turn on power to your circuit.
		Contact your place of purchase.
Flickers when dimming. (New installation)	Non-compatible dimmer used.	Check the dimmer used. Ensure the dimmer used is on the list of compatible dimmers in this manual.
	Some dimmers have a variable loading adjustment function. eg. Lucci LEDlux SKU# 290998 dimmer. This may not have been adjusted during the installation of the dimmer.	The variable resistor needs to be adjusted to suit the downlight load to reduce the flickering.
Flickers when dimming. (Existing installation)	Dimmer position on low.	Ensure the dimmer position is on the maximum setting before turning on the downlights and adjust the dimmer down to your desired light level.
Buzzing sound.	Non-compatible dimmer used.	Check the dimmer used. Ensure the dimmer used is on the list of compatible dimmers in this manual.
Uneven light start up.	Dimmer position on low when switched on.	Ensure the dimmer position is on the maximum setting before turning on the downlights and adjust the dimmer down to your desired light level.

Specifications		
SKU #	170890	
Colour	White	
Rated Voltage	220-240V~ 50Hz,	
Rated Wattage	10W	
LED Specs	Shineon LEDs, Dimmable, Colour Switching, CRI > 85	
Rated Lumens	3000K - 700 lumens 4000K - 800 lumens 5000K - 750 lumens	
Dimmer Information	Highly Recommended Dimmers	Lucci LEDlux SKU# 290998, SKU# 290997
	Compatible Dimmers	BUSTER+ PUNCH: DIM-002 LUMEX Load Smart LT1D450LS; DIGINET LED Smart MEDM; Clipsal 32EPUDM, 32E450UDM, 32E450TM, 31E2RUDM and 32ELEDM; HPM: Cat. 400T
Weight	0.3kg	
Cut-out Size	Ø 74mm	
IP Rating	IP44 for the front of the LED downlight module (after installation) IP20 for the back of the LED downlight module and LED driver	
Recessed Luminaire Classification	IC-4	
Dimensions	H:88mm Dia:84mm	
Serviceable Parts	LED downlight module and LED driver	
LED Driver Model #	LB-PD-1176-10W	