

SECURE 1LT FLOOD LIGHT WITH SENSOR

SKU# 240917

Rated Voltage 220-240V~ 50Hz

Thank you for purchasing this quality Lucci product. To ensure correct function and safety, please read and follow all instructions carefully before assembly, installation and use of this product. Please keep instructions for future reference.

Warranty

- This luminaire is covered by a 3-year warranty. The warranty is from date of purchase, not the date of installation.
- If the luminaire is not assembled and installed by a licensed electrician, the warranty will be void.
- Please retain the proof of purchase and evidence of installation by a licensed electrician for any warranty enquiries.
- Warranty will be void if there is any damage due to improper usage or modification to the luminaire.
- This luminaire is not suitable for use with dimmer switches. Warranty will be void if the luminaire is used on the same circuit, which has a dimmer switch.
- Failure to comply with the instructions in this manual may increase the risk of damage or injury and will void the warranty.

Installation Requirements

- This luminaire must be assembled and installed by a licensed electrician.
- All wiring and installation of the luminaire must adhere to the latest local and national wiring rules. E.g. AS/NZS 3000 Electrical Installations Do not exceed the maximum wattage rating.
- This luminaire is a Class II product and must be maintained during wiring and installation.
- This luminaire is rated IP54; this must be maintained during wiring and installation.
- Select a suitable location for installation:
 - The mounting point must support 2 times the weight of the luminaire.
 - This luminaire is protected against water penetration to IP54 standards, which is splashing water from any direction.
 - It is recommended the luminaire is installed on its own switch and not interconnected with other luminaires on the same switch, as it may cause the luminaire to switch on unintentionally.
 - Avoid installing the luminaire in close proximity or on the same circuit to any fluorescent luminaires or ceiling fans. RFI interference may cause the luminaire to switch on unintentionally.
 - See the **Sensor Information** section in this instruction manual for additional information about the sensor detection range and sensitivity, to select a suitable installation location.
- The luminaire is not suitable to use with dimmer switches and must not be used with a circuit which has a dimmer.
- The luminaire must not be used if the protective shield or shade has been cracked or damaged. Replace the protective shield or shade before using the luminaire.
- The colour temperature selection MUST be made during the installation, as the switch can only be accessed by a licensed electrician.
- Take care not to pull any electrical wires during unpacking as this may damage the connection.
- Lay out all the components on a smooth surface and make sure no components are missing before assembling. If parts are missing, return the complete product to the place of purchase for inspection or replacement.
- Check whether the luminaire has been damaged during transport. Do not operate/install any product which appears damaged in any way. Return the complete product to the place of purchase for inspection, repair or replacement.

Sensor Information

PIR (PASSIVE INFRA-RED) SENSOR:

The luminaire has a PIR (Passive Infra-Red) sensing device which continuously scans the operating zone and immediately switches the luminaire on when it detects any movement in that area. Whenever movement is detected within the sensor range, the luminaire will switch on automatically to illuminate the area.

NOTE: While there are movements within the sensor range, the luminaire will remain on.

SENSOR LOCATION & DETECTION:

- The ideal mounting height is between 1.8m – 2.5m (Fig. A)
- The detection area is approximately 12m away with an angle of 180°. The detection area will vary depending on the mounting height and items in the detection area. (Fig. A)
- The sensor has increased sensitivity with movement across the detection area. (Fig. B)
- The sensor has reduced sensitivity with movement towards and away from the detection area. (Fig. C)
- If movement is made walking directly towards or away from the sensor and not across its detection area, the detection range will be substantially reduced.
- The detection area may also alter at different temperatures. PIR sensors are more sensitive in cold weather than warm weather.
- To avoid damage to the sensor, do not aim the sensor towards the sun.
- To avoid false triggering:
 - The sensor should be directed away from potential heat sources such as barbecues, air conditioners, exhaust vents etc.
 - Avoid areas with strong electromagnetic disturbance, outside lighting, moving cars, trees, or pets.
 - Do not aim towards reflective surfaces, such as smooth white walls, swimming pools, ponds etc.
 - It is recommended the luminaire is installed on its own switch and not interconnected with other luminaires on the same switch.
 - Avoid installing the luminaire in close proximity or on the same circuit to any fluorescent luminaires or ceiling fans. RFI interference may cause the luminaire to switch on unintentionally.

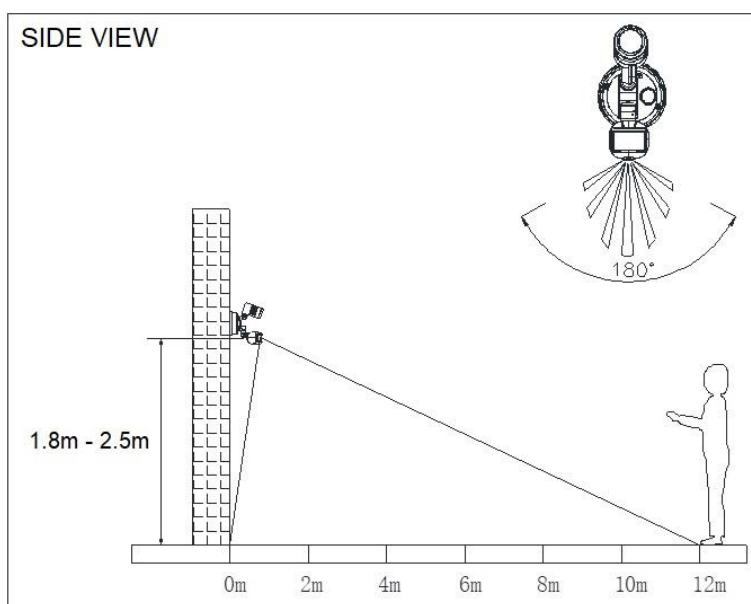

Fig. A

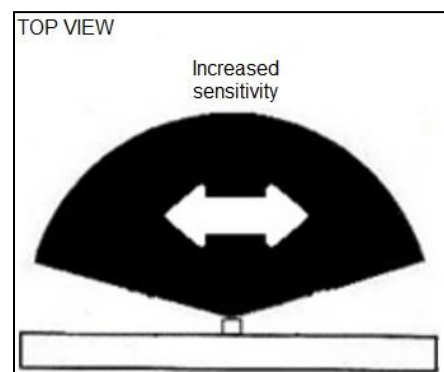

Fig. B

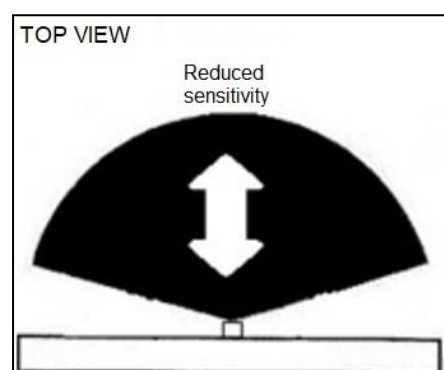

Fig. C

Installation Directions

1. Remove all packaging material from the product and be careful not to throw away accessories that may be hidden within the packaging material. If assembly is required, place the luminaire on a smooth non-scratch surface.
2. Ensure power to the circuit you are working on has been switched OFF before commencing any electrical work. (Fig.1)
3. Remove the mounting bracket from the luminaire by loosening the screws and the sealing rubber washers at the front of the luminaire. (Fig. 2 & 3)

NOTE: Carefully place the sealing rubber washers aside, they are required to be re-installed later and to maintain the IP54 rating for this luminaire.

4. Use the mounting bracket as a template to mark the screw positions on the wall. (Fig.4)
5. Connect the mains supply wire to the terminal block. Ensure the wires are secure and no bare wires are exposed. Secure the mains supply wire with the cord anchorage on the mounting bracket. (Fig. 5)

Mains Supply Wire

Neutral – Blue or Black

Live – Brown or Red

Luminaire Wire / Terminal Block

Blue or N

Brown or L

NOTE: This luminaire is a Class II product and must be maintained during the wiring and installation.

6. Install the mounting bracket onto the wall by using appropriately sized mounting screws, sealing rubber washers and anchors. Ensure the screws and anchors used are suitable for the mounting surface and the surrounding environment. (Fig. 6)

NOTE: A non-corrosive bead of silicone MUST be applied before installation onto the wall ensuring that no water can run down into the cabling.

7. Select the colour temperature by flicking the switch on the back of the luminaire. (Fig. 7)
WW – Warm White 3000K / CW – Cool White 4000K / NW – Daylight 5000K

NOTE: The colour temperature selection MUST be made during the installation as the switch can only be accessed by a licensed electrician.

8. Install the luminaire back onto the mounting bracket and secure by tightening the screws and the sealing rubber washers at the front of the luminaire. (Fig. 8)
9. After the installation is complete, turn the power to the circuit ON and test all the lighting functions of the luminaire before the licensed electrician leaves. (Fig. 9)

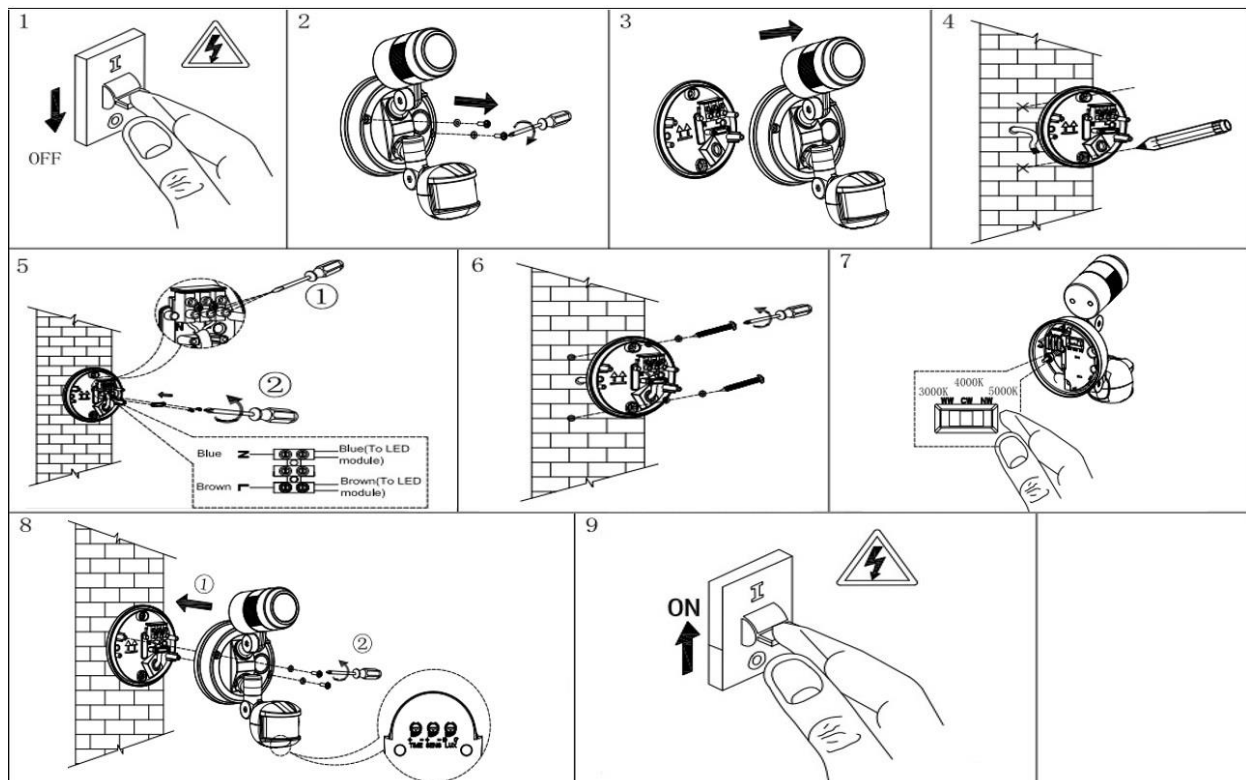

Sensor Settings

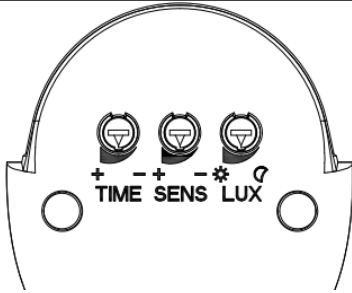

TIME: The duration time of the luminaire remains ON can be adjusted.

The (+) position means the luminaire will be ON for the maximum duration time of 4mins ±1mins.

The (-) position means the luminaire will be ON for the minimum duration time of 10secs ±5secs.

NOTE: Once the PIR sensor has been triggered, any subsequent detection will start the timed period again from the beginning, the sensor will remain on until there is no movement detected.

SENS: The detection distance of the sensor can be adjusted.

The (+) position means the sensor will be on maximum detection distance.

The (-) position means the sensor will be on minimum detection distance.

LUX: The sensor has a built-in sensing device (photocell) that detects daylight and darkness.

The (*) position means that the sensor will work at both day and night.

The (D) position will only work at night.

NOTE: If you want to test the detection area of the PIR sensor, please wait for the ambient light level is below 20 lux

Sensor Testing and Setup

1. Turn on the power to the luminaire, and it will enter the “WARM UP” period for about 30 seconds (within 1 minute). After the “WARM UP” period it will switch to “AUTO MODE”, and you can begin the sensor testing and setup.
2. Turn the LUX control knob to the daylight (*) position and the TIME control knob to the minimum (-).
3. When the sensor detects movement in the detection area, the luminaire will turn on.
4. Have someone slowly walk in front of the sensor to determine the detection area.
5. Adjust the TIME control knob to the desired length of time for the luminaire to remain on.
6. Adjust the LUX control knob to achieve the ideal ambient light for the luminaire to switch on.
For the luminaire to switch on when the ambient light is darker, turn the LUX control knob from (*) to (D).
For the luminaire to switch on when the ambient light is brighter, turn the LUX control knob from (D) to (*).
You may need to make further adjustments to achieve your ideal light level setting.

Sensor Modes

AUTO MODE: Switch the power on, and the luminaire will be on for about 30 seconds. When it turns off, wait 5 seconds, and the luminaire will now be in the auto mode. Now, the luminaire will switch on and off automatically when it detects any movement.

MANUAL MODE: While in auto mode, switch the power OFF-ON-OFF-ON within 3 seconds (toggle ON/OFF 2 times within 3 seconds). The luminaire will enter manual mode and will be continuously on for 8 hours (manual mode). After 8 hours, the sensor will return to the auto mode.

RESET: To return the sensor to auto mode during the manual mode, turn the power OFF for 10 seconds and ON again. The luminaire will now be in auto mode.

Safety Tips

- Always ensure the power is OFF and the luminaire has cooled down before performing any maintenance, cleaning or making any adjustment to the luminaire.
- To avoid injury or damage to the luminaire, ensure that power leads and screws are secure before connecting the power.
- To clean, wipe with a soft damp cloth. Do NOT soak or immerse the luminaire in water or other liquids.
- Ensure that the luminaire does not come in contact with corrosive chemicals/solvents or abrasive cleaners etc.
- The luminaire must not be used if the protective shield or shade has been cracked or damaged. Replace the protective shield or shade before using the luminaire.
- The light source of this luminaire is not replaceable; when the light source reaches its end of life, the whole luminaire shall be replaced. There are no serviceable parts, do not attempt to dismantle or open the luminaire.
- There are no serviceable parts inside the sensor, do not attempt to dismantle or open the sensor.

Specifications

SKU #	240917
Rated Voltage	220-240V~ 50Hz
Rated Wattage	10W
LED Specs	Non-dimmable, Colour Switching, CRI > 80
Lumens	3000K – 850 lumens 4000K – 900 lumens 5000K – 850 lumens
Weight	0.4kg
IP Rating	IP54
Dimensions	H:260mm W:190mm E:170mm MAX