

AMORE 2LT PLEATED WALL BRACKET

SKU# 309137,309140

Rated Voltage 220-240V~ 50Hz

Thank you for purchasing this quality Lucci product. To ensure correct function and safety, please read and follow all instructions carefully before assembly, installation and use of this product. Please keep instructions for future reference.

Warranty

- This luminaire is covered by a 12-month warranty. The warranty is from the date of purchase, not the date of installation.
- If the luminaire is not assembled and installed by a licensed electrician, the warranty will be void.
- Please retain the proof of purchase and evidence of installation by a licensed electrician for any warranty enquiries.
- Warranty will be void if there is any damage due to improper usage or modification to the luminaire.
- Failure to comply with the instructions in this manual may increase the risk of damage or injury and will void the warranty.

Installation Requirements

- This luminaire must be assembled and installed by a licensed electrician.
- All wiring and installation of the luminaire must adhere to the latest local and national wiring rules. E.g. AS/NZS 3000 Electrical Installations.
- The luminaire is a Class I product and must be earthed during wiring and installation.
- Do not exceed the maximum wattage rating.
- Select a suitable location for installation:
 - This luminaire is suitable for indoor use only.
 - The mounting point must support 2 times the weight of the luminaire.
 - Ensure the luminaire is not installed in the direct line of an air vent/system.
 - If installing a luminaire in an area prone to moisture, ensure that the area is well ventilated, and an appropriately rated exhaust fan is used if required. Damage or corrosion caused by moisture is not a product fault, and as such is not covered under warranty.
- Take care not to pull any electrical wires during unpacking as this may damage the connection.
- Lay out all the components on a smooth surface and make sure no components are missing before assembling. If parts are missing, return the complete product to the place of purchase for inspection or replacement.
- Check whether the luminaire has been damaged during transport. Do not operate/install any product which appears damaged in any way. Return the complete product to the place of purchase for inspection, repair or replacement.
- Ensure power to the circuit you are working on has been switched OFF before commencing any electrical work.

Installation Directions

1. Remove all packaging material from the product and be careful not to throw away accessories that may be hidden within the packaging material. If assembly is required, place the luminaire on a smooth non-scratch surface.
2. Remove the mounting bracket (B) from the luminaire (D) by loosening the screws (F).
3. Use the mounting bracket (B) as a template to mark the screw positions on the wall.
4. Install the mounting bracket (B) onto the wall by using appropriately sized mounting screws (C) and anchors (A). Ensure the screws (C) and anchors (A) used are suitable for the mounting surface and the surrounding environment.
5. Connect the mains supply wire to the terminal block (E).

Mains Supply Wire

Earth – Yellow/Green

Neutral – Blue or Black

Live – Brown or Red

Luminaire Wire / Terminal block

Yellow/Green or 

Blue or N

Brown or L

6. Ensure that the wires are secure, and no bare wires are exposed.

NOTE: The luminaire is a Class I product and must be earthed during wiring and installation.

7. Install the luminaire (D) onto the mounting bracket (B) and secure it by tightening the screws (F).
8. Install the luminaire shade (H) onto the luminaire (D) and secure it by tightening the socket ring (I) onto the lamp holder (G).
9. Install a LED globe (J – not included) into the lamp holder (G). Do not exceed the maximum wattage rating.
10. After the installation, switch on the luminaire to test all the lighting functions and enjoy your new lighting product.

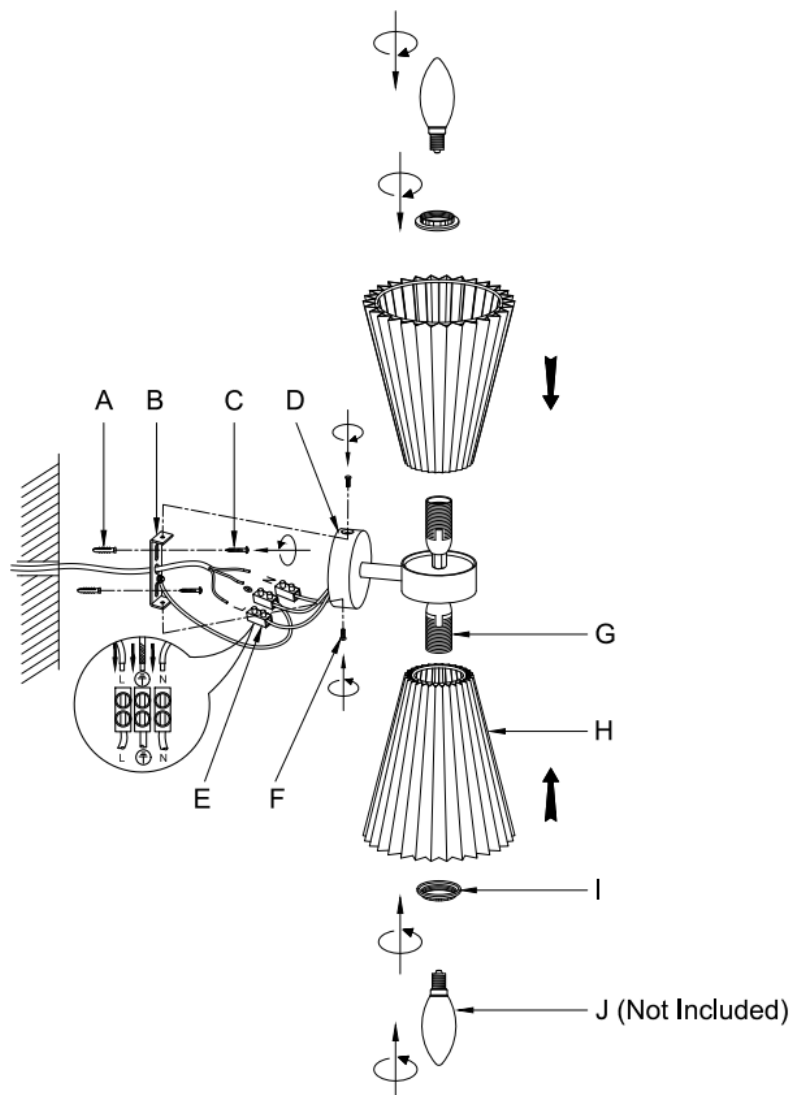

Safety Tips

- Always ensure the power is OFF and the luminaire has cooled down before performing any maintenance, cleaning, changing the globe or making any adjustment to the luminaire.
- The luminaire must not be used if the protective shield or shade has been cracked or damaged. Replace the protective shield or shade before using the luminaire.
- To avoid injury or damage to the luminaire, ensure that power leads and screws are secure before connecting the power.
- To clean, wipe with a soft damp cloth. Do NOT soak or immerse the luminaire in water or other liquids.
- Ensure that the luminaire does not come in contact with corrosive chemicals/solvents or abrasive cleaners etc.

Specifications

SKU #	309137	309140
Rated Voltage	220-240V~ 50Hz	
Rated Wattage	14W Max. (2x Max.7W, E14 LED Globe, not included)	
Lamp Holder	SES / E14	
Weight	0.6kg	
Dimensions	H:370mm W:155mm E:185mm	