

Installation Instructions
SKU# 060430, 060431 (LD-53026/5, LD-53026/6)
Rated Voltage 230-240V~ 50Hz

PLEASE READ ALL INSTRUCTIONS CAREFULLY BEFORE USING THE PRODUCT AND KEEP THE INSTRUCTIONS FOR FUTURE REFERENCE.

WARNING - to reduce the risk of fire, electrical shock or injury to persons or property, please follow the guideline below for safe use and installation.

INSTALLATION REQUIREMENTS:

- Must be installed by a licensed Electrician.
- Must be installed according to the current wiring rules AS/NZS3000.
- Do not exceed the maximum wattage rating.
- Suitability for use “indoors”.

INSTALLATION DIRECTIONS:

- Take care not to pull any wires during unpacking as a bad connection may occur.
 - Level all the components on a smooth surface and make sure there are no components missing before assembly.
 - Check whether the fitting has been damaged during transport. Do not operate/install any product which appears damaged in any way. Return the complete product to the place of purchase for inspection, repair or replacement.
 - Ensure all power connection is off for your own safety.
 - Select a suitable location to mount the fitting. Ensure it is away from any air vents, damp or moist areas and hazards. The mounting point must be able to support 4 times the weight of the fitting.
1. Loosen the mounting bracket from the canopy.
 2. Using the mounting bracket, mark the holes on the ceiling. Hammer the anchors into the holes.
 3. Drill holes in the ceiling and put the anchors into the holes. Secure the mounting bracket onto the ceiling via screws provided. Ensure the screws used are suitable for the mounting surface.
 4. Insert the fitting power cable through the canopy and rod and then use the black cloth sleeving to cover the chain and canopy rod. Secure the chain to the lamp body via the hook and hang up the fitting to the hook on the canopy.
 5. Connect the mains supply wire to the light fitting using the terminal block provided. Ensure that the wires are secure and no bare wires are exposed.

Mains Supply Wire

Earth – Yellow/Green
Neutral – Blue or Black
Live – Brown or Red

Fitting Wire

Yellow/Green ⊕
Blue
Brown

6. Attach the fitting to the mounting bracket and secure the canopy via tightening the screws on the rod.
7. Hang up the crystal kits and install light bulbs (not included).

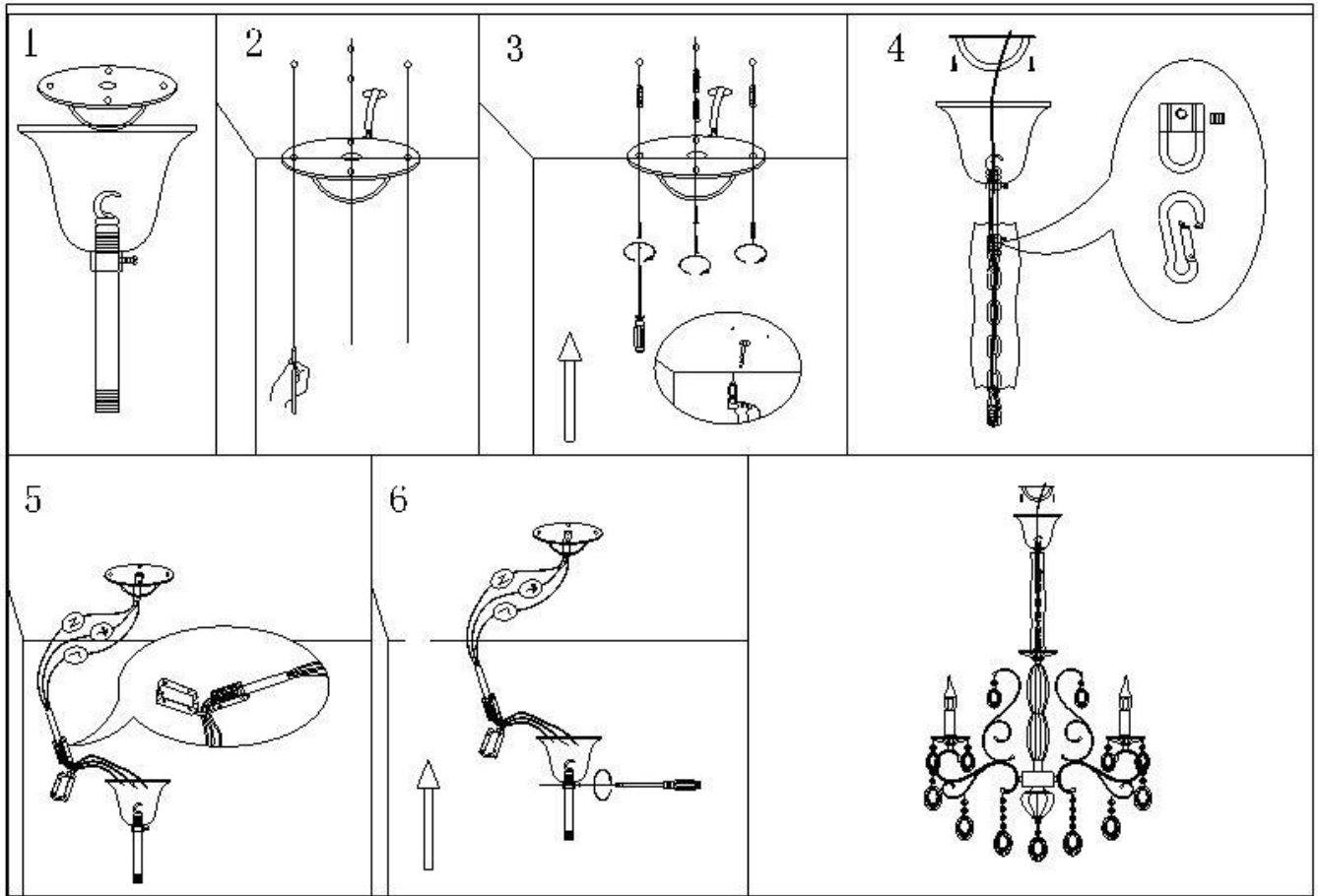

060431 (LD-53026/6)

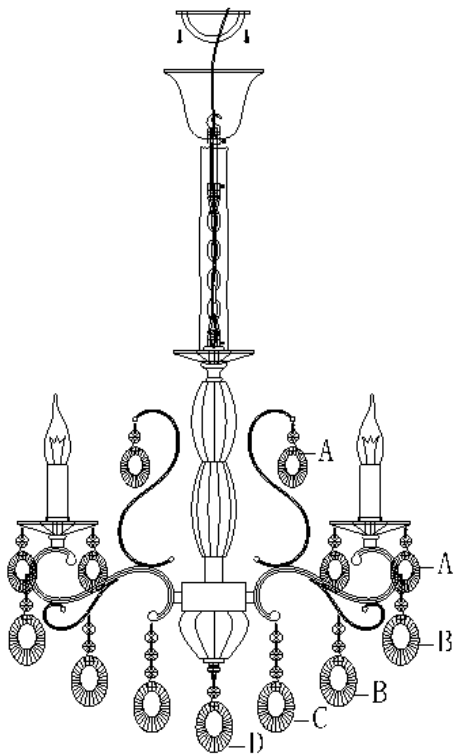

No.

Sets

A

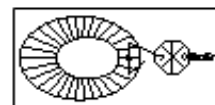

25

B

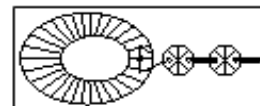

10

C

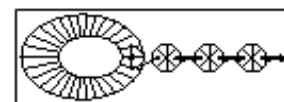

5

D

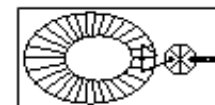

1

060430 (LD-53026/5)

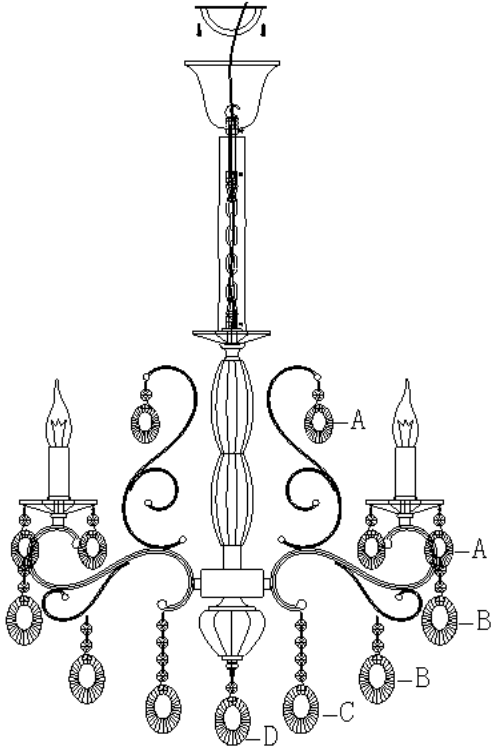

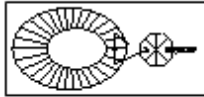
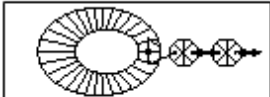
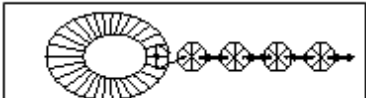
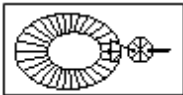
No.		Sets
A		30
B		12
C		6
D		1

TIPS:

1. To avoid injury or damage to the fitting, ensure that power leads and screws are secure before connecting the power.
2. Handle the fitting and cover/shade with care to avoid breakage.
3. When changing or cleaning bulbs, turn OFF power and allow cooling. Do not touch globes with bare hands, use gloves or a tissue.
4. Ensure that the fitting does not come in contact with corrosive chemicals, etc.
5. To clean, wipe with a damp clean cloth. Never soak the fitting with water.

SPECIFICATIONS:

SKU #	MODEL #	RATED VOLTAGE	RATED WATTAGE	LAMP HOLDER
060430	LD-53026/5	230-240V~50Hz	5x Max. 40W	E14
060431	LD-53026/6	230-240V~50Hz	6x Max. 40W	E14